





Bathtubs





Sense Dual

Bathtub

Sense Dual

Rectangular bathtub

cm 190x140 capacity 430 lt

FEATURES



Bath mounted mixer



4 Waterproof loudspeakers



2 white head rest in leather.



Disinfection system



Touch screen remote control



Whirlpool 10 jets in chromed brass



Airpool 14 jets in chromed brass



MP3 Connection

SEN719014T7-A0A

= SEN719014T7

+ -A0

+ A

-A0

-U0

A

U

P







Q

T

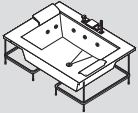
How to choose your product using the codes:

Bathtub	Measurements (cm)	Code	Bathtub finish		Deck mounted finish					Price
			glossy	soft	shiny white	soft white	ash	white oak	teak	

BUILT-IN VERSION

Bathtub	Measurements (cm)	Code	-A0	-U0	A	U	P	Q	T	Price
					shiny white	soft white	ash	white oak	teak	
	193 x 140 x 64 H	SEN719014T7								

FEATURES : 14 Airpool nozzles, 10 Whirlpool nozzles, 2 white head rest in leather, head rest, Disinfection system, Bath mounted mixer, Chromo light, Touch screen remote control, Radio RDS Stereo with 4 loudspeakers, MP3 AUX plug. Whirlpool functions: electronic intensity control, modulation effect and water's heater. Airpool functions: Airpool non-stop or intermittent.



Compulsory
Imperial to Metric flex waste adaptor

Code	RISCCAB
Price	

OPTIONAL PANELS

1 FRONT PANEL

Bathtub	Measurements (cm)	Code	A	U	P	Q	T	Price
			shiny white	soft white	ash	white oak	teak	
	193 x 140 x 64 H	PANVFSE194-						

1 FRONT PANEL + 1 SIDE PANEL

Bathtub	Measurements (cm)	Code	A	U	P	Q	T	Price
			shiny white	soft white	ash	white oak	teak	
	193 x 140 x 64 H	PANVFLSE194-						

1 FRONT PANEL + 2 SIDE PANELS

Bathtub	Measurements (cm)	Code	A	U	P	Q	T	Price
			shiny white	soft white	ash	white oak	teak	
	193 x 140 x 64 H	PANVF2LSE194-						

2 FRONT PANEL + 2 SIDE PANELS

Bathtub	Measurements (cm)	Code	A	U	P	Q	T	Price
			shiny white	soft white	ash	white oak	teak	
	193 x 140 x 64 H	PANVFLSE194C-						

For technical diagrams see page 203

FLOOR-MOUNTED MIXER

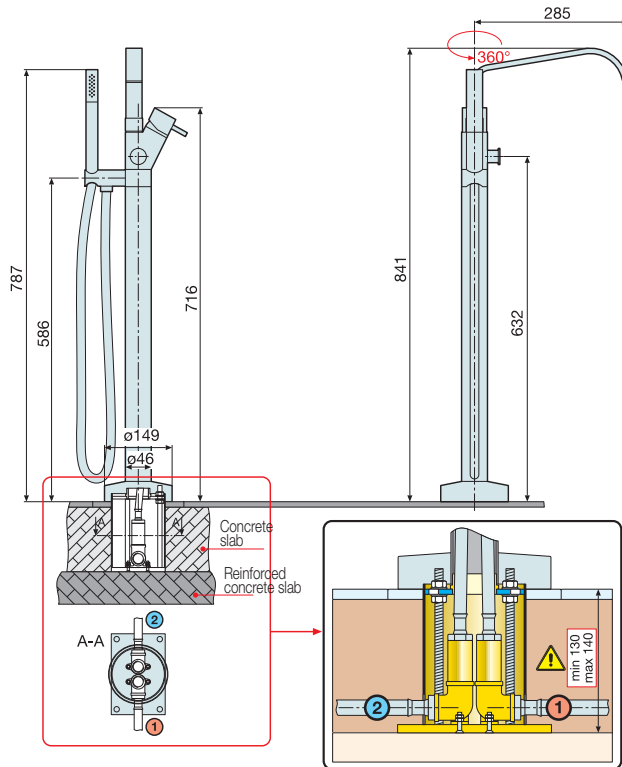

ATTENTION:

The column base must be installed before floor foundation. Please comply with the given measurements.

HYDRAULIC CHARACTERISTICS

- Optimum dynamic pressure 2-5 bar
- Bath filler water flow rate: 16 lit/min at 3 bar.
- Hand Shower water flow rate: 11 lit/min at 3 bar.

SENSE 1

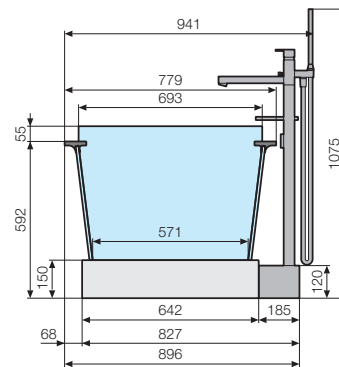
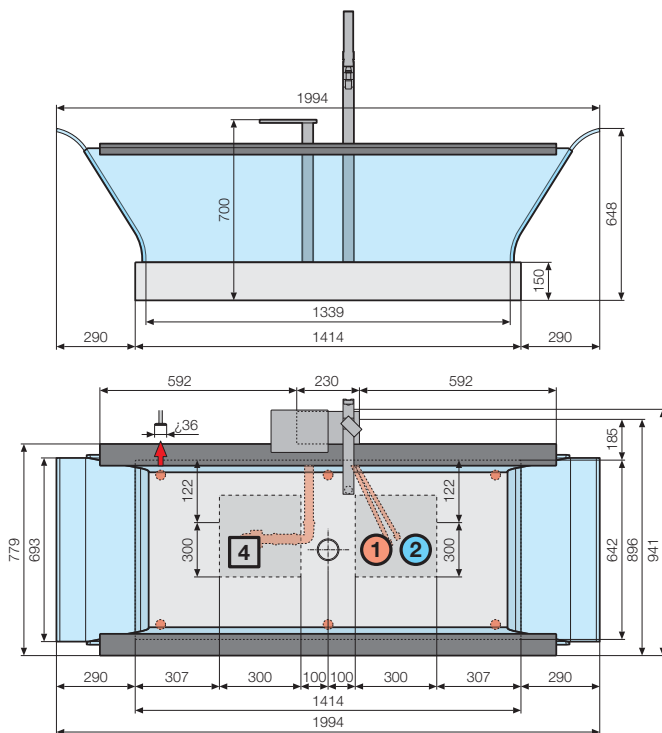

4 Recommended position for floor drainpipe.

HYDRAULIC CHARACTERISTICS

- Syphon connection 1 1/2"

SENSE DUAL

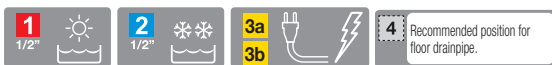
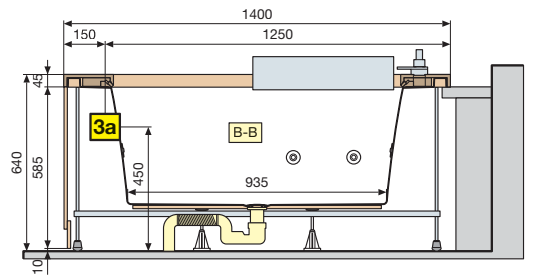
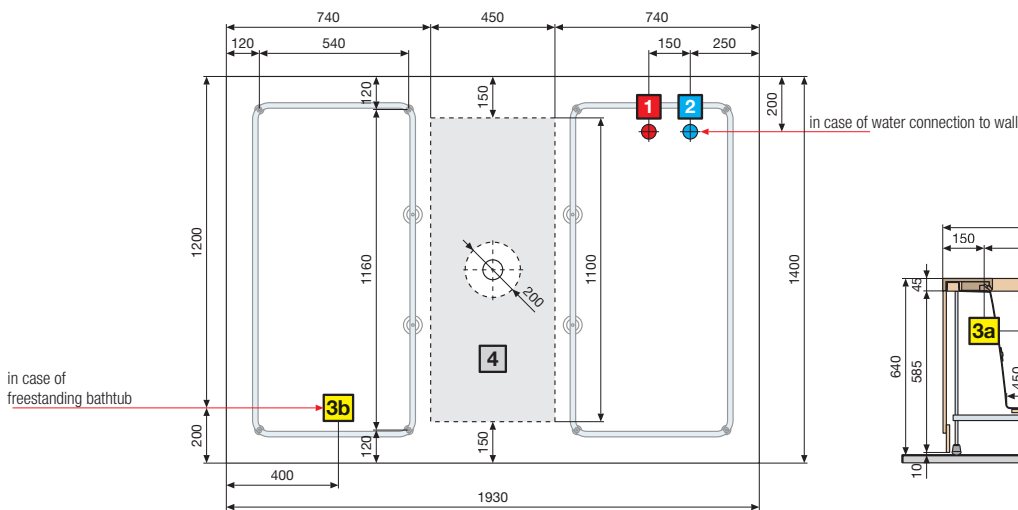
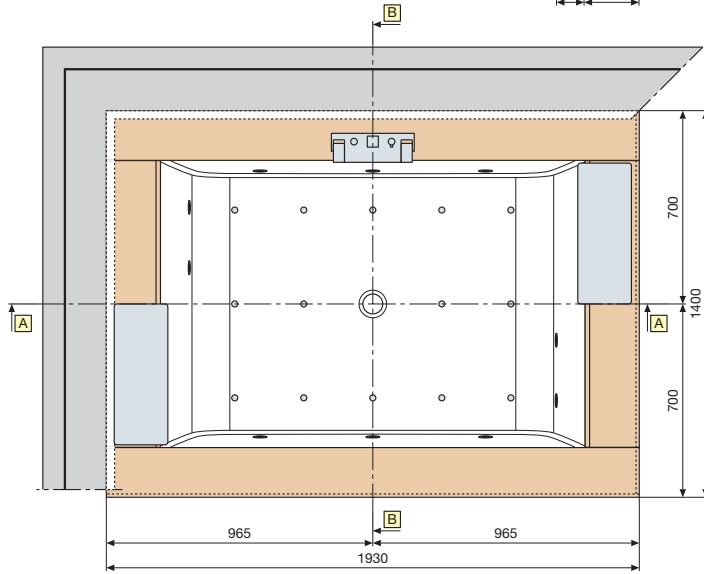
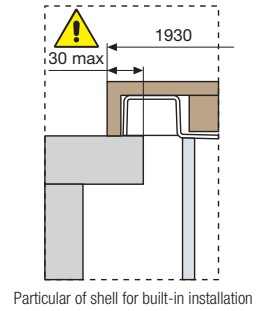
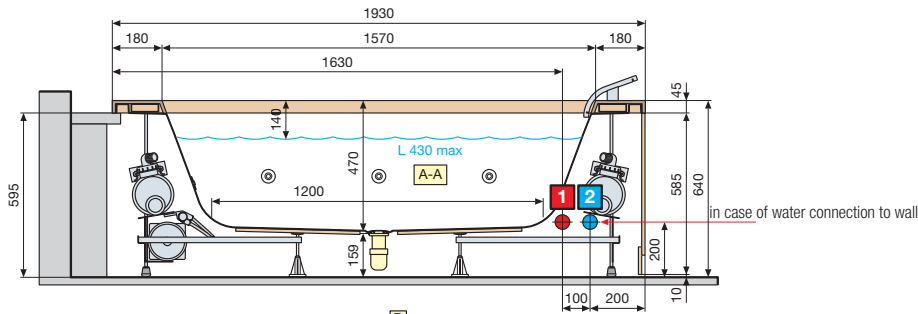

The whirlpool bath system must be fitted upstream with a 30 mA circuit breaker with a minimum contact of 3mm.

HYDRAULIC CHARACTERISTICS

- 10 whirlpool nozzles
- 14 airpool nozzles
- Siphon connection with 1 1/2" coupling

ELECTRICAL CHARACTERISTICS

- Voltage 230 V
- Frequency 50 Hz
- Maximum absorbed power: whirlpool + airpool: 3600 W