

Coral

altezza box / shower height



200 cm

altezza totale / total height

204 cm

crystallo trasparente / clear glass

8 mm

OLYMPIC PLUS	cm	Spessore/Rim 11,5 cm	Spessore/Rim 4,5 cm	Bianco/White + cod. 30	Nero/Black + cod. 28
	120 x 70	OL1207011-	OL120704-		
	120 x 80	OL8012011-	OL801204-		
	140 x 70	OL1407011-	OL140704-		
	140 x 75	OL1407511-	OL140754-		
	140 x 80	OL1408011-	OL140804-		
	140 x 90	OL1409011-	OL140904-		
	150 x 75	OL1507511-	OL150754-		
	160 x 70	OL1607011-	OL160704-		

cm	Spessore/Rim 11,5 cm	Spessore/Rim 4,5 cm	Bianco/White + cod. 30	Nero/Black + cod. 28
160 x 75	OL1607511-	OL160754-		
160 x 80	OL1608011-	OL160804-		
160 x 90	OL1609011-	OL160904-		
170 x 70	OL1707011-	OL170704-		
170 x 75	OL1707511-	OL170754-		
170 x 80	OL1708011-	OL170804-		
170 x 90	OL1709011-	OL170904-		
180 x 75	OL1807511-	OL180754-		

Esempio compilazione codice piatti doccia: / How to choose your product using the codes: **OL1207011-30** = **OL1207011-** + **30**

Compatibilità piatti doccia Novellini / For shower trays, p. 466. Per compatibilità con altri piatti doccia. / For compatibility with other shower trays, see p. 480-481.

ref. 3 Coral 2P - Porta doccia a 2 ante, 1 battente + 1 fissa, in nicchia / In line hinged door and panel for recess

Versione Sinistra
Left Version

Versione Destra
Right Version

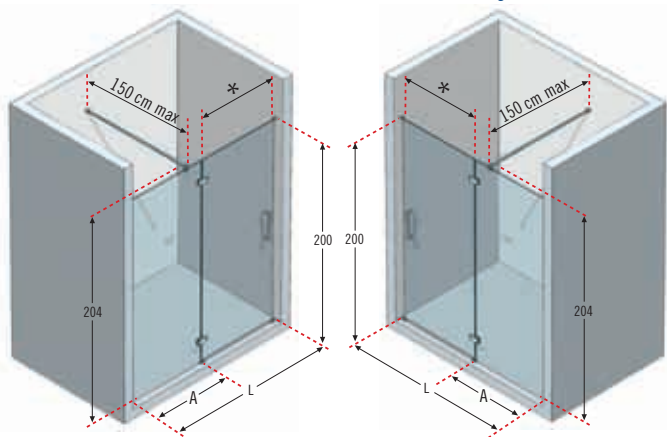

NOVITÀ Cerniere incollate
NEW Glued hinges



vista interna / internal view



vista esterna / external view

STANDARD 150 CM

Barra di sostegno (fornita con ogni porta)
Support bar (supplied with each door)

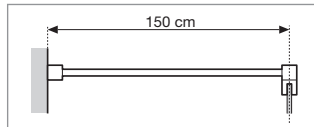

Maggiori informazioni per la scelta PRECISA del vostro modello vedere pag. 43.

For more help with choosing EXACTLY the model you want, see page 43.

Come rilevare le misure vedi pag. 42. / How to take the measurement see page 42.

ref. 4 Coral 2P+F - Porta doccia a 2 ante, 1 battente + 1 fissa con parete fissa laterale / Corner shower cubicle with hinged door + two fixed panels

Versione Sinistra
Left Version

Versione Destra
Right Version

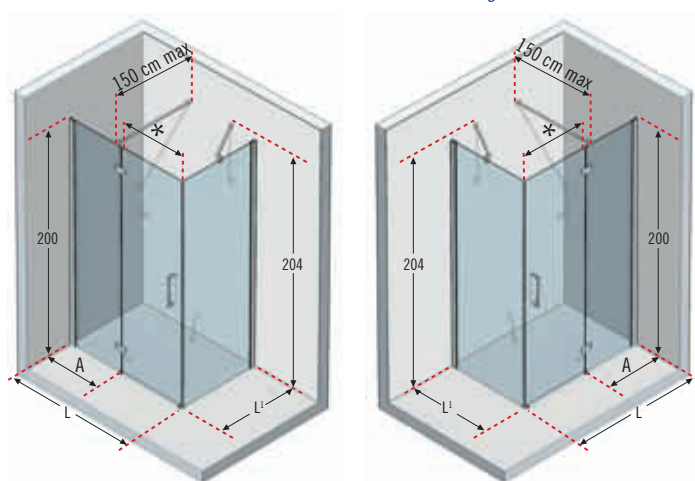

NOVITÀ Cerniere incollate
NEW Glued hinges



vista interna / internal view



vista esterna / external view

STANDARD 150 CM

Barra di sostegno (fornita con ogni porta)
Support bar (supplied with each door)

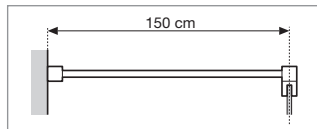

Maggiori informazioni per la scelta PRECISA del vostro modello vedere pag. 44.

For more help with choosing EXACTLY the model you want, see page 44.

Come rilevare le misure vedi pag. 42. / How to take the measurement see page 42.

Codice/Code: **CORAL2P115S-1K**

CORAL2P115

S-

1

K

Esempio compilazione codice:
How to choose your product using the codes:

CORAL2P115



S-

D-

1

B

K

Misure Measurements (cm)	Entrata Access (cm)	Ingombro anta esterno Projection	Codice Code	Sinistra Left	Destra Right	Vetro Glass	Scelta profilo / Profile type	
				S-	D-		1	B
L **	A	*		Sinistra Left	Destra Right	Trasparente Clear	Silver	Cromo Chrome
114,5 ↔ 117	44,5 ↔ 47	62	CORAL2P115				<input type="checkbox"/>	<input type="checkbox"/>
117 ↔ 119,5	47 ↔ 49,5	62	CORAL2P120				<input type="checkbox"/>	<input type="checkbox"/>
137 ↔ 139,5	67 ↔ 69,5	62	CORAL2P140				<input type="checkbox"/>	<input type="checkbox"/>
157 ↔ 159,5	77 ↔ 79,5	72	CORAL2P160				<input type="checkbox"/>	<input type="checkbox"/>
177 ↔ 179,5	87 ↔ 89,5	82	CORAL2P180				<input type="checkbox"/>	<input type="checkbox"/>

Il codice comprende: porta + scatola di montaggio. / The code comprehends door and assembly kit.

PORTA SPECIALE IN LARGHEZZA (Misure speciali consegna massimo 6 settimane) / **SPECIAL DOOR ON WIDTH** (Delivery on 6 weeks)

H 170 ↓ 220	L 117 ↔ 177		CORAL2PSP	<input type="checkbox"/>	<input type="checkbox"/>	<input type="checkbox"/>	<input type="checkbox"/>	<input type="checkbox"/>
-------------	-------------	--	------------------	--------------------------	--------------------------	--------------------------	--------------------------	--------------------------

Il codice comprende: porta + scatola di montaggio. / The code includes door and assembly kit.

L **	***	A	*	Codice Code	Sinistra Left	Destra Right	Trasparente Clear	Silver	Cromo Chrome
					S-	D-			
115,5 ↔ 118	117,5 ↔ 120	47 ↔ 49,5	61	CORAL2PF120				<input type="checkbox"/>	<input type="checkbox"/>
135,5 ↔ 138	137,5 ↔ 140	67 ↔ 69,5	61	CORAL2PF140				<input type="checkbox"/>	<input type="checkbox"/>
155,5 ↔ 158	157,5 ↔ 160	77 ↔ 79,5	71	CORAL2PF160				<input type="checkbox"/>	<input type="checkbox"/>
175,5 ↔ 178	177,5 ↔ 180	87 ↔ 89,5	81	CORAL2PF180				<input type="checkbox"/>	<input type="checkbox"/>

Il codice comprende: porta + scatola di montaggio. / The code includes door and assembly kit.

FISSO (REVERSIBILE) ATTENZIONE: ORDINARE SEMPRE LA SCATOLA DI MONTAGGIO / **SIDE PANEL (REVERSIBLE)** ATTENTION: PLEASE ALWAYS ORDER THE ASSEMBLY KIT

L ¹ **	***	Codice Code	Trasparente Clear	Silver	Cromo Chrome
66 ↔ 68,5	67,5 ↔ 70	CORALF70-		<input type="checkbox"/>	<input type="checkbox"/>
71 ↔ 73,5	72,5 ↔ 75	CORALF75-		<input type="checkbox"/>	<input type="checkbox"/>
76 ↔ 78,5	77,5 ↔ 80	CORALF80-		<input type="checkbox"/>	<input type="checkbox"/>
86 ↔ 88,5	87,5 ↔ 90	CORALF90-		<input type="checkbox"/>	<input type="checkbox"/>
96 ↔ 98,5	97,5 ↔ 100	CORALF100-		<input type="checkbox"/>	<input type="checkbox"/>
106 ↔ 108,5	107,5 ↔ 110	CORALF110-		<input type="checkbox"/>	<input type="checkbox"/>
116 ↔ 118,5	117,5 ↔ 120	CORALF120-		<input type="checkbox"/>	<input type="checkbox"/>

PORTA SPECIALE IN LARGHEZZA (Misure speciali consegna massimo 6 settimane) / **SPECIAL DOOR ON WIDTH** (Delivery on 6 weeks)

H 170 ↓ 220	L 115,5 ↔ 175,5		CORAL2PFSP	<input type="checkbox"/>	<input type="checkbox"/>	<input type="checkbox"/>	<input type="checkbox"/>
-------------	-----------------	--	-------------------	--------------------------	--------------------------	--------------------------	--------------------------

Il codice comprende: porta + scatola di montaggio. / The code includes door and assembly kit.

PARETE FISSA SPECIALE IN LARGHEZZA (Misure speciali consegna massimo 6 settimane) / **SPECIAL SIDE PANEL ON WIDTH** (Delivery on 6 weeks)

H 170 ↓ 220	L 26 ↔ 121		CORALFSP	<input type="checkbox"/>	<input type="checkbox"/>	<input type="checkbox"/>	<input type="checkbox"/>
-------------	------------	--	-----------------	--------------------------	--------------------------	--------------------------	--------------------------

** misura d'ingombro del box doccia / overall dimension. *** misura da muro a bordo esterno del piatto doccia. / measure from wall to external edge of shower tray.

Dati tecnici / *Technical data*

Vetri *Glass types*



Trasparente
Clear

Finitura Profili *Profile colours*

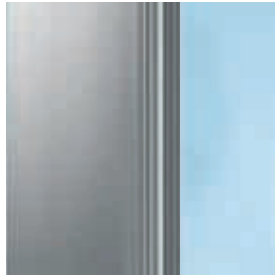

Silver



Cromo
Chrome

Maniglie *Handles*



Maniglia in metallo cromato
Chrome metallic handle

Cerniere incollate *Glued hinges*



Vista esterna
External view



Vista interna
Internal view

Trattamenti *Treatment*



TRATTAMENTO ANTIGOCCIA

Cristalli sempre brillanti, facili da pulire. Impedisce la formazione del calcare e dei batteri.

CRYSTAL CLEAR TREATMENT

*Leaves glass easy to clean.
Does not support the growth
of bacteria and scale.*

**DISPONIBILE SECONDO
SEMESTRE 2011**

**AVAILABLE FROM THE
SECOND SEMESTER 2011**



FINITURA CROMO

Ciclo di produzione integrata a zero emissioni, 100% ecologico. Anticalcare, antibatterica, ecologica brillantezza resistente nel tempo.

PVD CHROME FINISH

*Zero emission integrated cycle,
100% environment-friendly.
Antiscale, antibacteria, ecological,
long-time shining resistance.*

Come rilevare le misure / *How to take the measurement*

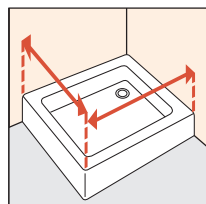
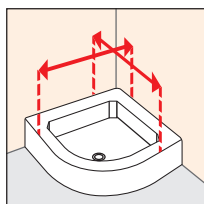

Rilevare le misure da muro a bordo esterno del piatto doccia. Le misure devono essere rilevate sulla parete finita, a rivestimenti posati, secondo gli schemi riportati.

Take the measurements from wall to the external edge of the shower tray. Measurements must be taken once the walls are finished and tiled, according to the above drawings.

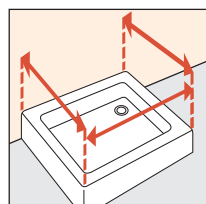

ref. **1** Coral A - Box doccia angolare / *Corner shower cubicle*

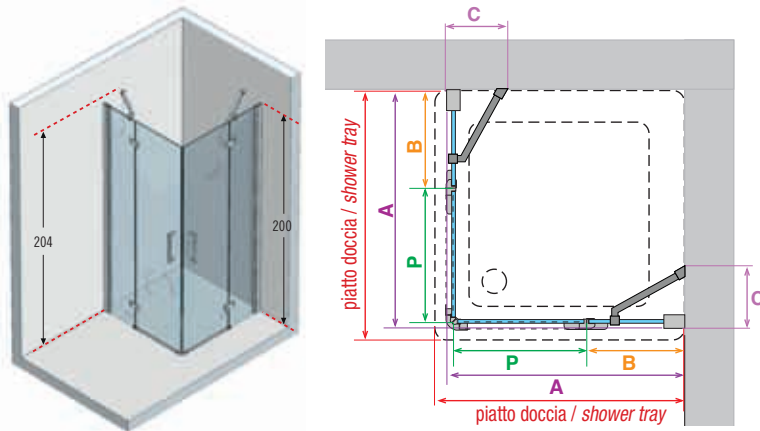

Codice Code	Misure piatto doccia da - a Measures shower trays from - to	P	B	A	C
CORALA80	77,5 - 80	52	22-24,5	76-78,5	17
CORALA90	87,5 - 90	52	32-34,5	86-88,5	23
CORALA100	97,5 - 100	62	32-34,5	96-98,5	23
CORALA110	107,5 - 110	72	32-34,5	106-108,5	23
CORALA120	117,5 - 120	72	42-44,5	116-118,5	27

ref. **2** Coral R - Box doccia curvo a 2 battenti
Curved shower cubicle with two hinged doors

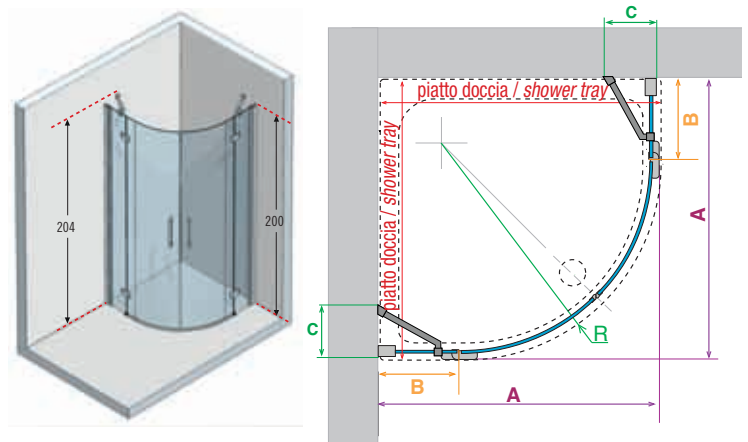

Codice Code	Misure piatto doccia da - a Measures shower trays from - to	A	B	C	R raggio radius
CORALR80	77,5 - 80	76,5-79	12-14,5	16	55
CORALR90	87,5 - 90	86,5-89	22-24,5	17	55
CORALR100	97,5 - 100	96,5-99	32-34,5	23	55

ref. **3** Coral 2P - Porta doccia a 2 ante, 1 battente + 1 fissa, in nicchia
In line hinged door and panel for recess

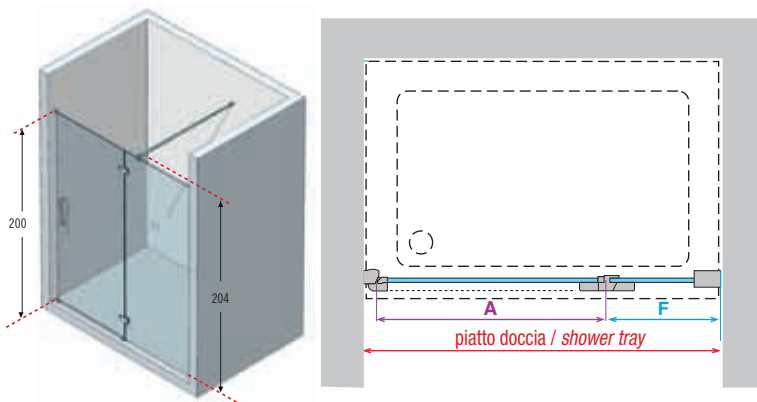

Codice Code	Misure piatto doccia da - a Measures shower trays from - to	A	F
SX CORAL2P120S-	117 - 119,5	62	52-54,5
DX CORAL2P120D-			
SX CORAL2P140S-	137 - 139,5	62	72-74,5
DX CORAL2P140D-			
SX CORAL2P160S-	157 - 159,5	72	82-84,5
DX CORAL2P160D-			
SX CORAL2P180S-	177 - 179,5	82	92-94,5
DX CORAL2P180D-			

ref. **5** Coral 2A - Porta doccia a 4 ante, 2 battenti + 2 fisse, in nicchia
Four section enclosure, two hinged + two fixed for recess

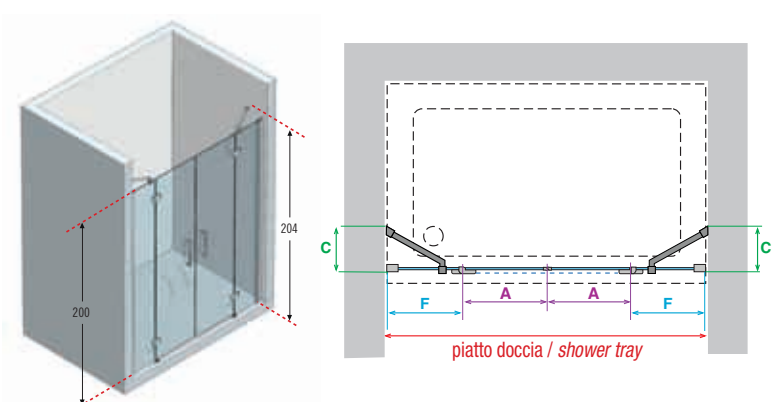

Codice Code	Misure piatto doccia da - a Measures shower trays from - to	A	F	C
CORAL2A120	115 - 120	35	22-24,5	17
CORAL2A140	135 - 140	35	32-34,5	23
CORAL2A150	145 - 150	40	32-34,5	23
CORAL2A160	155 - 160	45	32-34,5	23
CORAL2A170	165 - 170	40	42-44,5	27
CORAL2A180	175 - 180	45	42-44,5	27