



NEXIS 1 R90 1/4 de cercle / Quadrant shower

Nexis 1

Verre 6 mm trempé de sécurité certifié
Safety glass 6 mm complying
with European Standards
UNI EN 14428

Code: NEXR90M1-1KA	=	NEXR90M1-1K	+	A			
Exemple de composition du code: How to choose your product using the codes:		NEXR90M1-1K		A	P	Q	T

Mitigeur Mixer	Mesures Measurements (cm)	*	Code Code	Choix finition HPL Chosen HPL finishing	Prix Price
-------------------	---------------------------------	---	--------------	--	---------------

Nexis 1 R90 - 1/4 de cercle / Quadrant shower

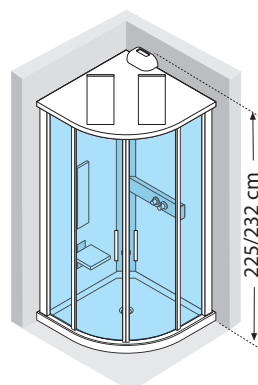
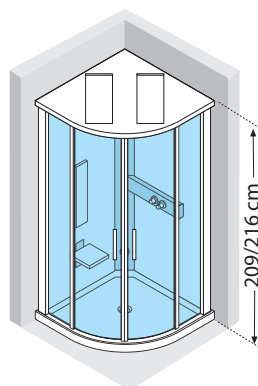
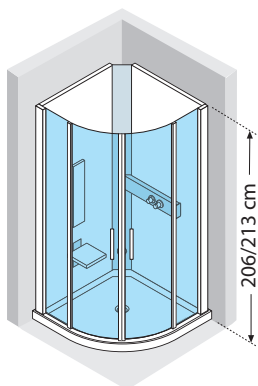

VERSION HYDRO / HYDRO VERSION				A	P	Q	T
SANS COIFFE / WITHOUT DOME				blanc white	frêne ash	rouvre blanchi white oak	tek teak
MÉCANIQUE MANUAL	90 x 90 x 206 H	h 8	NEXR90M1-1K				
	90 x 90 x 213 H	h 15	NEXR99M1-1K				
THERMOSTATIQUE THERMOSTATIC	90 x 90 x 206 H	h 8	NEXR90T1-1K				
	90 x 90 x 213 H	h 15	NEXR99T1-1K				

FINITION: Siège en HPL finition bois inclinable, Dossier en laminé HPL avec finition bois, Hydromassage vertical réglable, Douchette à main en laiton chromé, Caillebotis en laminé HPL avec finition bois, Étagère porte-objets

FEATURES: Folding seat in leafy HPL with finish wood, Back in leafy HPL with finish wood, Adjustable vertical hydromassage, Shower hand in chromed brass, Shower tray base in leafy HPL with finish wood, Soap holders in leafy HPL with finish wood

AVEC COIFFE ET DOUCHE ZÉNITHALE / WITH DOME AND SHOWER HEAD				A	P	Q	T
				blanc white	frêne ash	rouvre blanchi white oak	tek teak
MÉCANIQUE MANUAL	90 x 90 x 209 H	h 8	NEXR90M1F-1K				
	90 x 90 x 216 H	h 15	NEXR99M1F-1K				
THERMOSTATIQUE THERMOSTATIC	90 x 90 x 209 H	h 8	NEXR90T1F-1K				
	90 x 90 x 216 H	h 15	NEXR99T1F-1K				

FINITION: Siège en HPL finition bois inclinable, Dossier en laminé HPL avec finition bois, Hydromassage vertical réglable, Douchette à main en laiton chromé, Caillebotis en laminé HPL avec finition bois, Étagère porte-objets avec finition bois, Coiffe en laminé HPL avec finition bois avec douche zénithale

FEATURES: Folding seat in leafy HPL with finish wood, Back in leafy HPL with finish wood, Adjustable vertical hydromassage, Shower hand in chromed brass, Shower tray base in leafy HPL with finish wood, Soap holders in leafy HPL with finish wood, Dome in HPL with shower head

VERSION PLUS / PLUS VERSION				A	P	Q	T
AVEC COIFFE - HAMMAM ET DOUCHE ZÉNITHALE / WITH DOME - STEAM GENERATOR AND SHOWER				blanc white	frêne ash	rouvre blanchi white oak	tek teak
MÉCANIQUE MANUAL	90 x 90 x 225 H	h 8	NEXR90M5-1K				
	90 x 90 x 232 H	h 15	NEXR99M5-1K				
THERMOSTATIQUE THERMOSTATIC	90 x 90 x 225 H	h 8	NEXR90T5-1K				
	90 x 90 x 232 H	h 15	NEXR99T5-1K				

FINITION: Coiffe en laminé HPL avec finition bois, Hydromassage vertical réglable, Douche zénithale, Douchette à main en laiton chromé, Siège en HPL finition bois inclinable, Dossier en laminé HPL avec finition bois, Étagère porte-objets avec finition bois, Caillebotis en laminé HPL avec finition bois, hammam plus (diffuseur de vapeur, diffuseur d'arômes, Radio FM RDS Stereo, prise audio pour MP3, spot Chromolight), Télécommande Touch Screen

FEATURES: Dome in leafy HPL with finish wood, Adjustable vertical hydromassage, Shower head, Shower hand in chromed brass, Folding seat in leafy HPL with finish wood, Back in leafy HPL with finish wood, Soap holders in leafy HPL with finish wood, Shower tray base in leafy HPL with finish wood, Sauna plus (steam and aroma dispenser, Radio FM RDS Stereo, MP3 AUX plug, Cromolight lamp), Touch screen remote control

* Hauteur receveurs / shower tray height.

Finition p. 18, données techniques voir p. 21. / Features page 18, technical diagrams page 21.

Données techniques / *Technical data*

Verre *Glass types*



Transparent
Clear

Finition profilés *Profile colours*



Chrome

Traitement *Treatment*



TRAITEMENT ANTI-GOUTTES
Cristal toujours brillant, facile à nettoyer. Empêche le dépôt du calcaire et des bactéries.

CRYSTAL CLEAR TREATMENT
Leaves glass easy to clean. Does not support the growth of bacteria and scale.



PVD FINITION CHROME

Sans aucune émission nocive. Anticalcaire, Antibactérien, Ecologique. Aspect brillant durable.

PVD CHROME FINISH
Zero emission integrated cycle, 100% environment-friendly. Antiscale, antibacteria, ecological, long-time shining resistance.

ACS ATTESTATION DE CONFORMITÉ SANITAIRE

Toutes les robinetteries Novellini et Elysium sont conformes à l'attestation de conformité sanitaire.

All Novellini and Elysium taps and fittings comply with ACS (attestation de conformité sanitaire).

Montage sans silicone
Assembling without silicon

Laminé HPL finition bois / *Leafy HPL with finish wood*



blanc
white



frêne
ash

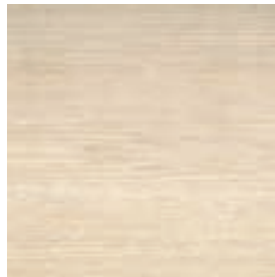

rouvre blanchi
white oak

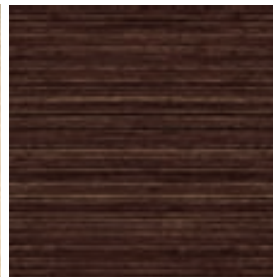

tek
teak

Le laminé HPL est un matériau avec une surface très résistante à la griffure, à l'abrasion, à l'eau et à la chaleur. Il est facile à nettoyer et il est idéal pour les applications où l'hygiène est essentielle, comme dans les salles de bains.

The leafy HPL is a material with a very resistant surface to the scratches, to the abrasion, to the water and the heat. The leafy HPL is easy to be cleaned and therefore ideal for applications where the hygiene is essential, as in the baths.

Finition / *Features*

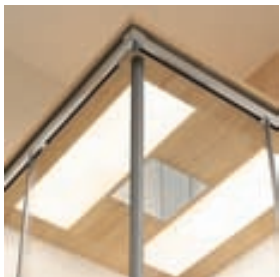

Coiffe en laminé HPL avec finition bois, Douche zénithale
Dome in leafy HPL with finish wood



Hydromassage vertical réglable
Adjustable vertical hydromassage



Siège en HPL finition bois inclinable, dossier en HPL finition bois fixation magnétique
Folding seat in leafy HPL with finish wood, Back in leafy HPL with finish wood with magnetic fixing

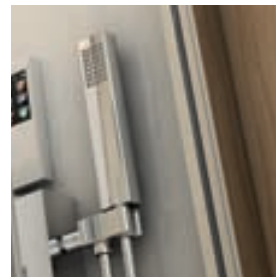

Douchette à main en laiton chromé
Hand shower in chromed brass



Télécommande Touch screen
Touch screen Remote Control



Caillebotis en laminé HPL avec finition bois / *Shower tray base in leafy HPL with finish wood*



Diffuseur d'arômes
Aroma dispenser



Connexion MP3
MP3 Connection

NEXIS 1 R90

RECEVEUR BAS H 8 CM / LOW TRAY H 8 CM

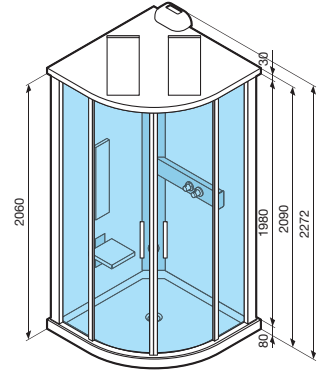
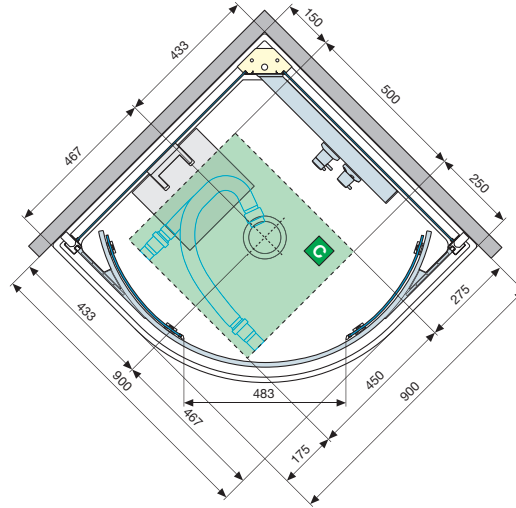
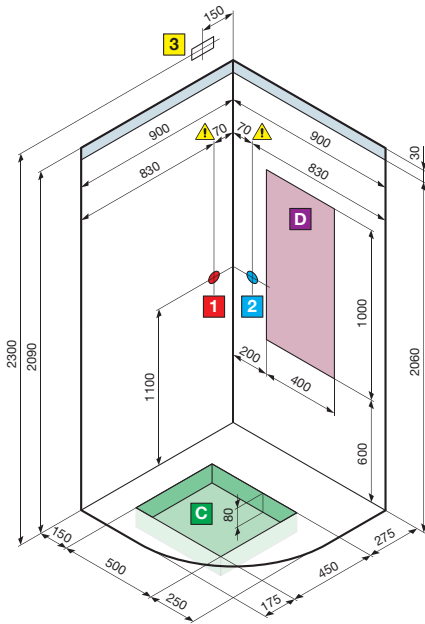

RECEVEUR HAUT H 15 CM / HIGH TRAY H 15 CM

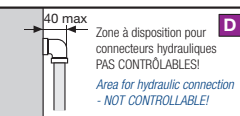
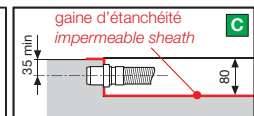
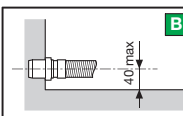
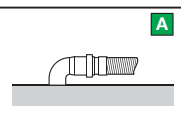
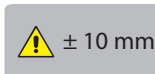
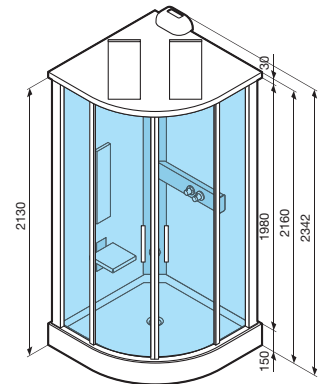
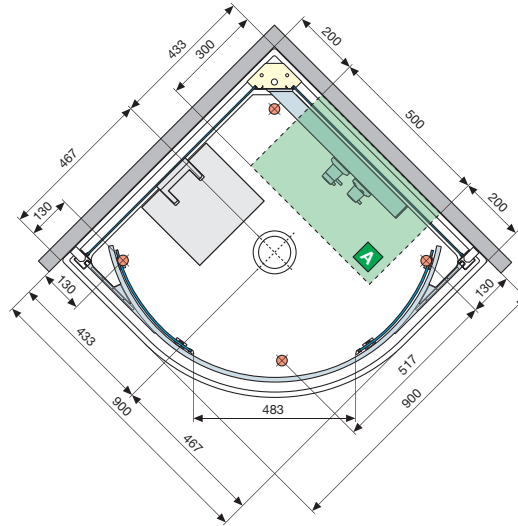
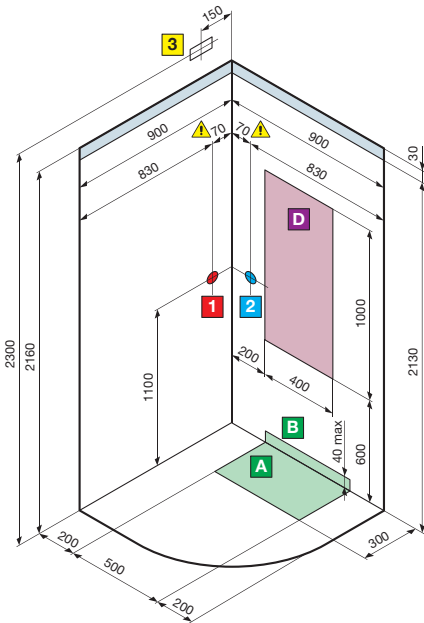

CARACTERISTIQUES HYDRAULIQUES

- Pression dynamique optimale 2÷5 bar
- Raccordement eau chaude 1/2"
- Raccordement eau froide 1/2"
- Bonde diam. 40 mm

HYDRAULIC CHARACTERISTIC

- Optimum dynamic pressure 2-5 bar
- 1/2" hot water connection
- Cold water connection 1/2"
- Siphon connection with 40 mm diameter coupling

CARACTERISTIQUES ELECTRIQUES

- 220-230 V
- 50/60 Hz
- Absorption maximale: 3300 W
- Puissance nominale: 2500 W

ELECTRICAL CHARACTERISTIC

- Supply voltage 220-230 V
- Frequency 50/60 Hz
- Maximum absorbed power: 3300 W
- Nominal power 2500 W