



ref. **4** Coral 2P+F - Porte à 2 panneaux dont 1 pivotant + panneau fixe latéral / Corner shower cubicle with hinged door + two fixed panels



CORAL

Coral

# Coral

hauteur paroi / shower height



**200 cm**

hauteur totale / total height

**204 cm**

crystal transparent / clear glass

**8 mm**

OLYMPIC PLUS	cm	Bord/Rim 11,5 cm	Bord/Rim 4,5 cm	Bianco/White + cod. 30	Nero/Black + cod. 28
	120 x 70	<b>OL1207011-</b>	<b>OL120704-</b>		
	120 x 80	<b>OL8012011-</b>	<b>OL801204-</b>		
	140 x 70	<b>OL1407011-</b>	<b>OL140704-</b>		
	140 x 75	<b>OL1407511-</b>	<b>OL140754-</b>		
	140 x 80	<b>OL1408011-</b>	<b>OL140804-</b>		
	140 x 90	<b>OL1409011-</b>	<b>OL140904-</b>		
	150 x 75	<b>OL1507511-</b>	<b>OL150754-</b>		
	160 x 70	<b>OL1607011-</b>	<b>OL160704-</b>		

cm	Bord/Rim 11,5 cm	Bord/Rim 4,5 cm	Bianco/White + cod. 30	Nero/Black + cod. 28
160 x 75	<b>OL1607511-</b>	<b>OL160754-</b>		
160 x 80	<b>OL1608011-</b>	<b>OL160804-</b>		
160 x 90	<b>OL1609011-</b>	<b>OL160904-</b>		
170 x 70	<b>OL1707011-</b>	<b>OL170704-</b>		
170 x 75	<b>OL1707511-</b>	<b>OL170754-</b>		
170 x 80	<b>OL1708011-</b>	<b>OL170804-</b>		
170 x 90	<b>OL1709011-</b>	<b>OL170904-</b>		
180 x 75	<b>OL1807511-</b>	<b>OL180754-</b>		

Exemple de composition du code receveurs de douche: / How to choose your product using the codes: **OL1207011-30** = **OL1207011-** + **30**

Compatibilité avec receveurs de douche Novellini / For shower trays, p. 466. Pour compatibilité avec autres receveurs de douche / For compatibility with other shower trays, p. 480-481.

## ref. 3 Coral 2P - Porte en niche 1 pivotant + 1 fixe / In line hinged door and panel for recess

Version Gauche  
Left Version

Version Droite  
Right Version

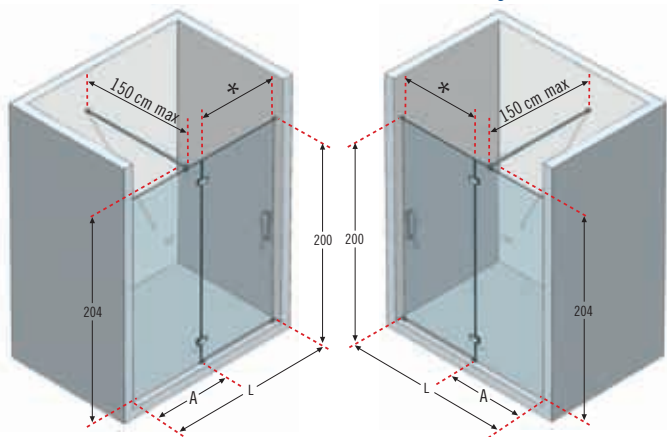

**NOUVEAUTÉ** Charnières collées  
**NEW** Glued hinges



vue intérieure / internal view



vue extérieure / external view

**STANDARD 150 CM**

Barre de renfort (Fourni avec chaque fixe)

Support bar (supplied with each side panel)

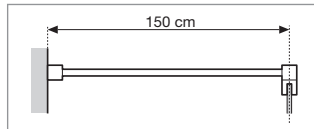

Pour le détail des mesures voir p. 43.

For more help with choosing EXACTLY the model you want, see page 43.

Comment relever les mesures voir p. 42. / How to take the measurement see page 42.

## ref. 4 Coral 2P+F - Porte à 2 panneaux dont 1 pivotant + panneau fixe latéral / Corner shower cubicle with hinged door + two fixed panels

Version Gauche  
Left Version

Version Droite  
Right Version

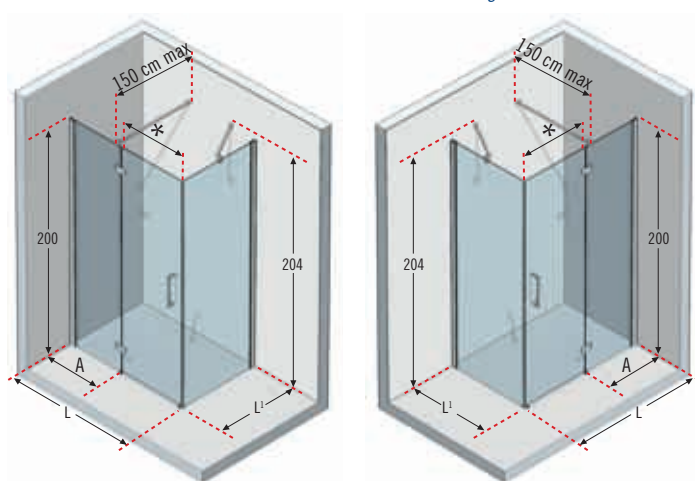

**NOUVEAUTÉ** Charnières collées  
**NEW** Glued hinges



vue intérieure / internal view



vue extérieure / external view

**STANDARD 150 CM**

Barre de renfort (Fourni avec chaque fixe)

Support bar (supplied with each side panel)

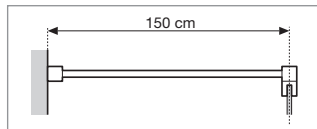

Pour le détail des mesures voir p. 44.

For more help with choosing EXACTLY the model you want, see page 44.

Comment relever les mesures voir p. 42. / How to take the measurement see page 42.



## Données techniques / *Technical data*

### Verre *Glass types*

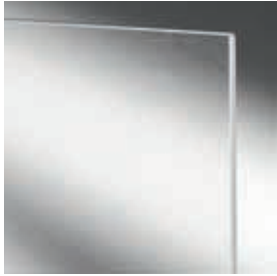

Transparent  
*Clear*

### Finition profilés *Profile colours*

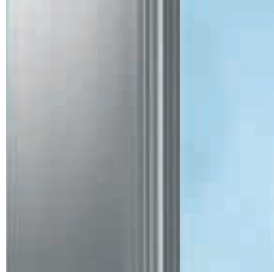

Silver



Chrome

### Poignée *Handle*



Poignée métallique chrome  
*Chrome metallic handle*

### Charnières collées *Glued hinges*



Vue extérieure  
*External view*



Vue intérieure  
*Internal view*

### Traitement *Treatment*



#### **TRAITEMENT ANTI-GOUTTES**

Cristal toujours brillant, facile à nettoyer. Empêche le dépôt du calcaire et des bactéries.

#### **CRYSTAL CLEAR TREATMENT**

*Leaves glass easy to clean. Does not support the growth of bacteria and scale.*

**DISPONIBLE A PARTIR DE LE  
DEUXIÈME SEMESTRE 2011  
AVAILABLE FROM THE  
SECOND SEMESTER 2011**



#### **PVD FINITION CHROME**

Sans aucune émission nocive. Anticalcaire, Antibactérien, Ecologique. Aspect brillant durable.

#### **PVD CHROME FINISH**

*Zero emission integrated cycle, 100% environment-friendly. Antiscale, antibacteria, ecological, long-time shining resistance.*

## Comment relever les mesures / *How to take the measurement*

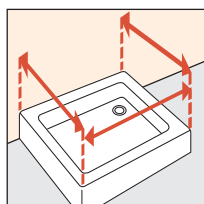
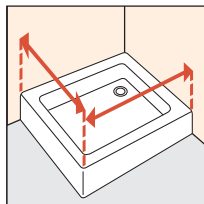
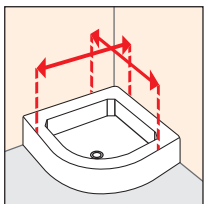

Prendre les mesures du mur au bord extérieur du receveur de douche. Relever les mesures après la pose du carrelage.

*Take the measurements from wall to the external edge of the shower tray. Measurements must be taken once the walls are finished and tiled, according to the above drawings.*

# Données techniques / Technical drawings

ref. **4** Coral 2P+F - Porte à 2 panneaux dont 1 pivotant + panneau fixe latéral  
Corner shower cubicle with hinged door + two fixed panels

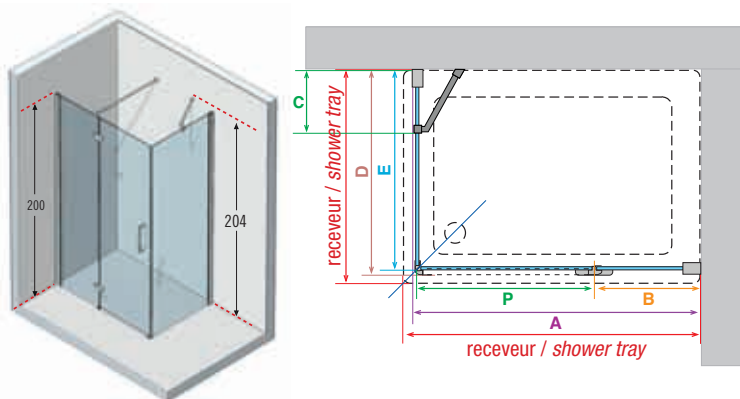

## PORTE / DOOR

Code	Dimensions paroi de - a Measures shower trays from - to	P	B	A
<b>SX</b> CORAL2PF120S	117,5 - 120	62	52-54,5	115,5-118
<b>DX</b> CORAL2PF120D				
<b>SX</b> CORAL2PF140S	137,5 - 140	62	72-74,5	135,5-138
<b>DX</b> CORAL2PF140D				
<b>SX</b> CORAL2PF160S	157,5 - 160	72	82-84,5	155,5-158
<b>DX</b> CORAL2PF160D				
<b>SX</b> CORAL2PF180S	177,5 - 180	82	92-94,5	175,5-178
<b>DX</b> CORAL2PF180D				

## FIXE / SIDE PANEL

Code	Dimensions paroi de - a Measures shower trays from - to	D	E	C
<b>CORALF70</b>	67,5 - 70	66-68,5	64-66,5	27
<b>CORALF75</b>	72,5 - 75	71-73,5	69-71,5	27
<b>CORALF80</b>	77,5 - 80	76-78,5	74-76,5	27
<b>CORALF90</b>	87,5 - 90	86-88,5	84-86,5	27
<b>CORALF100</b>	97,5 - 100	96-98,5	94-96,5	27
<b>CORALF110</b>	107,5 - 110	106-108,5	104-106,5	27
<b>CORALF120</b>	117,5 - 120	116-118,5	114-116,5	27

ref. **8** Coral G+F - Paroi de douche avec porte pivotante + panneau fixe en angle / Hinged door and side panel

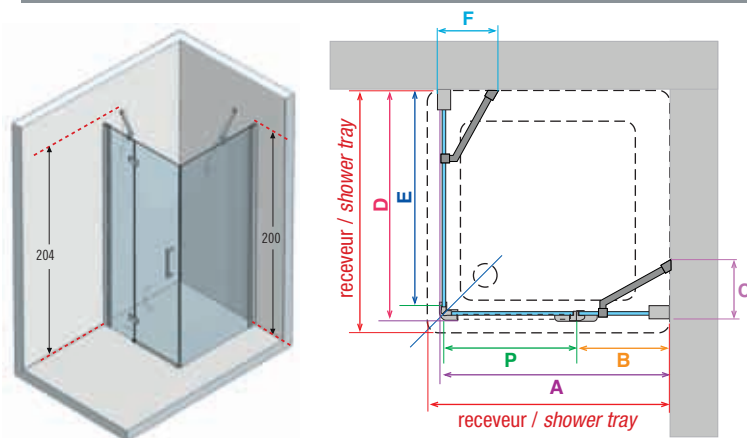

## PORTE / DOOR

Code	Dimensions paroi de - a Measures shower trays from - to	P	B	A	C
<b>SX</b> CORALA80LS	77,5 - 80	52	22-24,5	76-78,5	17
<b>DX</b> CORALA80LD					
<b>SX</b> CORALA90LS	87,5 - 90	52	32-34,5	86-88,5	23
<b>DX</b> CORALA90LD					
<b>SX</b> CORALA100LS	97,5 - 100	62	32-34,5	96-98,5	23
<b>DX</b> CORALA100LD					
<b>SX</b> CORALA110LS	107,5 - 110	72	32-34,5	106-108,5	23
<b>DX</b> CORALA110LD					
<b>SX</b> CORALA120LS	117,5 - 120	72	42-44,5	116-118,5	27
<b>DX</b> CORALA120LD					

## FIXE / SIDE PANEL

Code	Dimensions paroi de - a Measures shower trays from - to	D	E	F
<b>CORALF70</b>	67,5 - 70	66-68,5	64-66,5	27
<b>CORALF75</b>	72,5 - 75	71-73,5	69-71,5	27
<b>CORALF80</b>	77,5 - 80	76-78,5	74-76,5	27
<b>CORALF90</b>	87,5 - 90	86-88,5	84-86,5	27
<b>CORALF100</b>	97,5 - 100	96-98,5	94-96,5	27
<b>CORALF110</b>	107,5 - 110	106-108,5	104-106,5	27
<b>CORALF120</b>	117,5 - 120	116-118,5	114-116,5	27

ref. **7** Coral 1B - Porte pivotante en niche / Hinged door for recess

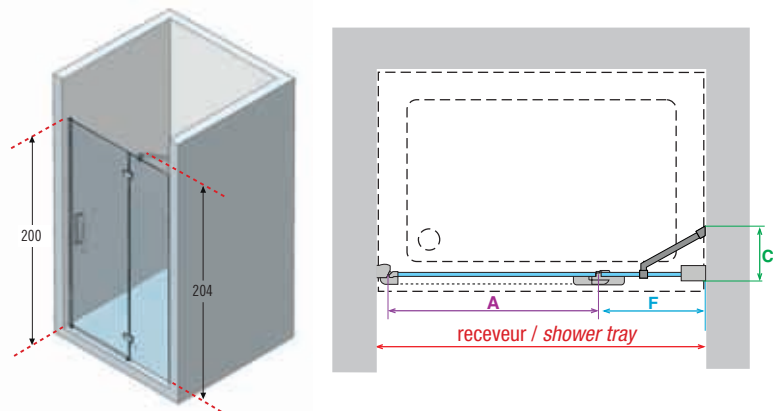

Code	Dimensions paroi de - a Measures shower trays from - to	A	F	C
<b>CORAL1B80</b>	77 - 79,5	52	22-24,5	17
<b>CORAL1B90</b>	87 - 89,5	52	32-34,5	23
<b>CORAL1B100</b>	97 - 99,5	62	32-34,5	23