

Coral

hauteur paroi / shower height



200 cm

hauteur totale / total height

204 cm

crystal transparent / clear glass

8 mm

OLYMPIC PLUS	cm	Bord/Rim 11,5 cm	Bord/Rim 4,5 cm	Bianco/White + cod. 30	Nero/Black + cod. 28
	120 x 70	OL1207011-	OL120704-		
	120 x 80	OL8012011-	OL801204-		
	140 x 70	OL1407011-	OL140704-		
	140 x 75	OL1407511-	OL140754-		
	140 x 80	OL1408011-	OL140804-		
	140 x 90	OL1409011-	OL140904-		
	150 x 75	OL1507511-	OL150754-		
	160 x 70	OL1607011-	OL160704-		

cm	Bord/Rim 11,5 cm	Bord/Rim 4,5 cm	Bianco/White + cod. 30	Nero/Black + cod. 28
160 x 75	OL1607511-	OL160754-		
160 x 80	OL1608011-	OL160804-		
160 x 90	OL1609011-	OL160904-		
170 x 70	OL1707011-	OL170704-		
170 x 75	OL1707511-	OL170754-		
170 x 80	OL1708011-	OL170804-		
170 x 90	OL1709011-	OL170904-		
180 x 75	OL1807511-	OL180754-		

Exemple de composition du code receveurs de douche: / How to choose your product using the codes: **OL1207011-30** = **OL1207011-** + **30**

Compatibilité avec receveurs de douche Novellini / For shower trays, p. 466. Pour compatibilité avec autres receveurs de douche / For compatibility with other shower trays, p. 480-481.

ref. 3 Coral 2P - Porte en niche 1 pivotant + 1 fixe / In line hinged door and panel for recess

Version Gauche
Left Version

Version Droite
Right Version

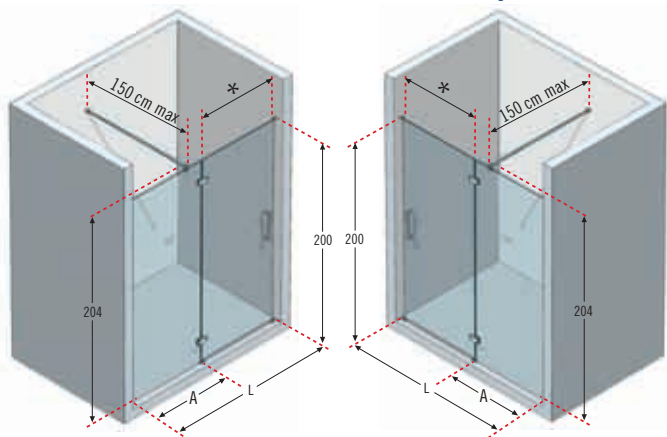

NOUVEAUTÉ Charnières collées
NEW Glued hinges



vue intérieure / internal view



vue extérieure / external view

STANDARD 150 CM

Barre de renfort (Fourni avec chaque fixe)

Support bar (supplied with each side panel)

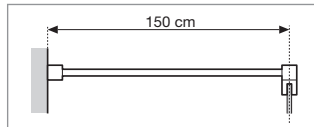

Pour le détail des mesures voir p. 43.

For more help with choosing EXACTLY the model you want, see page 43.

Comment relever les mesures voir p. 42. / How to take the measurement see page 42.

ref. 4 Coral 2P+F - Porte à 2 panneaux dont 1 pivotant + panneau fixe latéral / Corner shower cubicle with hinged door + two fixed panels

Version Gauche
Left Version

Version Droite
Right Version

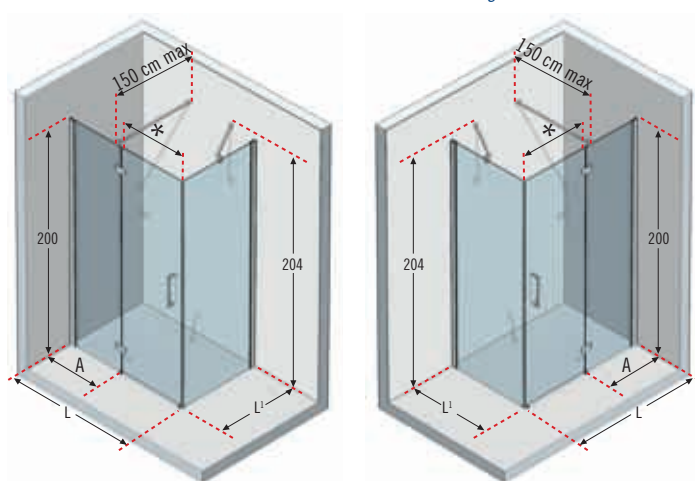

NOUVEAUTÉ Charnières collées
NEW Glued hinges



vue intérieure / internal view



vue extérieure / external view

STANDARD 150 CM

Barre de renfort (Fourni avec chaque fixe)

Support bar (supplied with each side panel)

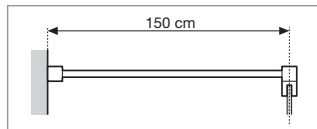

Pour le détail des mesures voir p. 44.

For more help with choosing EXACTLY the model you want, see page 44.

Comment relever les mesures voir p. 42. / How to take the measurement see page 42.

Code: **CORAL2P115S-1K****CORAL2P115****S-****1****K**

Exemple de composition du code:

How to choose your product using the codes:

CORAL2P115**S-****D-****1****B****K**

Mesures Measurements (cm)	Passage Access (cm)	Encombrement extérieur de la porte Projection	Code Code	Gauche Left	Droite Right	Verre Glass	Choix profilé / Profile type	
							B	K
L **	A	*		S-	D-	1	B	K
				Gauche Left	Droite Right	Transparent Clear	Silver	Chrome
114,5 ↔ 117	44,5 ↔ 47	62	CORAL2P115					
117 ↔ 119,5	47 ↔ 49,5	62	CORAL2P120					
137 ↔ 139,5	67 ↔ 69,5	62	CORAL2P140					
157 ↔ 159,5	77 ↔ 79,5	72	CORAL2P160					
177 ↔ 179,5	87 ↔ 89,5	82	CORAL2P180					

Le code comprend: porte + kit de montage. / The code comprehends door and assembly kit.

PORTE EN MESURE SPÉCIALE (Délai 6 semaines maximum) / **SPECIAL DOOR ON WIDTH** (Delivery on 6 weeks)

H 170 ↓ 220	L 117 ↔ 177		CORAL2PSP					
-------------	-------------	--	------------------	--	--	--	--	--

Le code comprend: porte + kit de montage. / The code includes door and assembly kit.

L **	***	A	*	Code	Gauche Left	Droite Right	Verre Glass	Choix profilé / Profile type	
								B	K
115,5 ↔ 118	117,5 ↔ 120	47 ↔ 49,5	61	CORAL2PF120					
135,5 ↔ 138	137,5 ↔ 140	67 ↔ 69,5	61	CORAL2PF140					
155,5 ↔ 158	157,5 ↔ 160	77 ↔ 79,5	71	CORAL2PF160					
175,5 ↔ 178	177,5 ↔ 180	87 ↔ 89,5	81	CORAL2PF180					

Le code comprend: porte + kit de montage. / The code includes door and assembly kit.

PAROI FIXE (REVERSIBLE) / SIDE PANEL (REVERSIBLE)

L ¹ **	***	Code	Verre Glass	Choix profilé / Profile type	
				B	K
66 ↔ 68,5	67,5 ↔ 70	CORALF70-			
71 ↔ 73,5	72,5 ↔ 75	CORALF75-			
76 ↔ 78,5	77,5 ↔ 80	CORALF80-			
86 ↔ 88,5	87,5 ↔ 90	CORALF90-			
96 ↔ 98,5	97,5 ↔ 100	CORALF100-			
106 ↔ 108,5	107,5 ↔ 110	CORALF110-			
116 ↔ 118,5	117,5 ↔ 120	CORALF120-			

PORTE EN MESURE SPÉCIALE (Délai 6 semaines maximum) / **SPECIAL DOOR ON WIDTH** (Delivery on 6 weeks)

H 170 ↓ 220	L 115,5 ↔ 175,5		CORAL2PFSP					
-------------	-----------------	--	-------------------	--	--	--	--	--

Le code comprend: porte + kit de montage. / The code includes door and assembly kit.

PANNEAU FIXE EN MESURE SPÉCIALE (Délai 6 semaines maximum) / **SPECIAL SIDE PANEL ON WIDTH** (Delivery on 6 weeks)

H 170 ↓ 220	L 26 ↔ 121		CORALFSP					
-------------	------------	--	-----------------	--	--	--	--	--

** mesure d'encombrement de la paroi de douche / overall dimension. *** mesure du mur au bord externe du receveur de la douche / measure from wall to external edge of shower tray.

Données techniques / *Technical data*

Verre *Glass types*

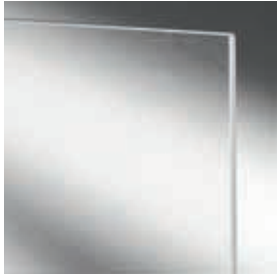

Transparent
Clear

Finition profilés *Profile colours*

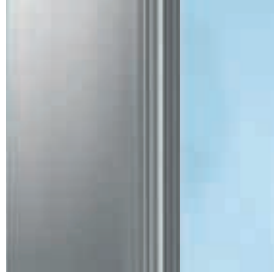

Silver



Chrome

Poignée *Handle*



Poignée métallique chrome
Chrome metallic handle

Charnières collées *Glued hinges*



Vue extérieure
External view



Vue intérieure
Internal view

Traitement *Treatment*



TRAITEMENT ANTI-GOUTTES

Cristal toujours brillant, facile à nettoyer. Empêche le dépôt du calcaire et des bactéries.

CRYSTAL CLEAR TREATMENT

Leaves glass easy to clean. Does not support the growth of bacteria and scale.

**DISPONIBLE A PARTIR DE LE
DEUXIÈME SEMESTRE 2011
AVAILABLE FROM THE
SECOND SEMESTER 2011**



PVD FINITION CHROME

Sans aucune émission nocive. Anticalcaire, Antibactérien, Ecologique. Aspect brillant durable.

PVD CHROME FINISH

Zero emission integrated cycle, 100% environment-friendly. Antiscale, antibacteria, ecological, long-time shining resistance.

Comment relever les mesures / *How to take the measurement*

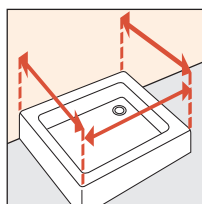
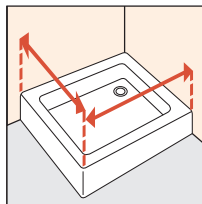
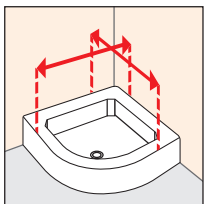

Prendre les mesures du mur au bord extérieur du receveur de douche. Relever les mesures après la pose du carrelage.

Take the measurements from wall to the external edge of the shower tray. Measurements must be taken once the walls are finished and tiled, according to the above drawings.

Données techniques / Technical drawings

ref. **1** **Coral A** - Paroi de douche accès d'angle pivotant
Corner shower cubicle

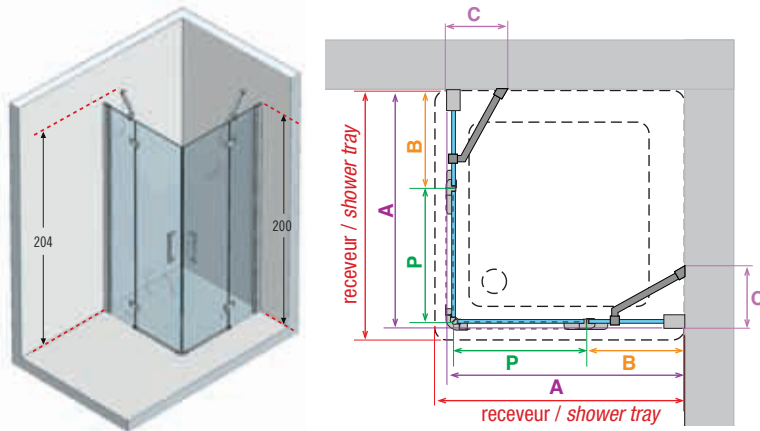

Code	Dimensions paroi de - a Measures shower trays from - to	P	B	A	C
CORALA80	77,5 - 80	52	22-24,5	76-78,5	17
CORALA90	87,5 - 90	52	32-34,5	86-88,5	23
CORALA100	97,5 - 100	62	32-34,5	96-98,5	23
CORALA110	107,5 - 110	72	32-34,5	106-108,5	23
CORALA120	117,5 - 120	72	42-44,5	116-118,5	27

ref. **2** **Coral R** - Paroi de douche 1/4 de cercle à 2 portes pivotantes cintrées / Curved shower cubicle with two hinged doors

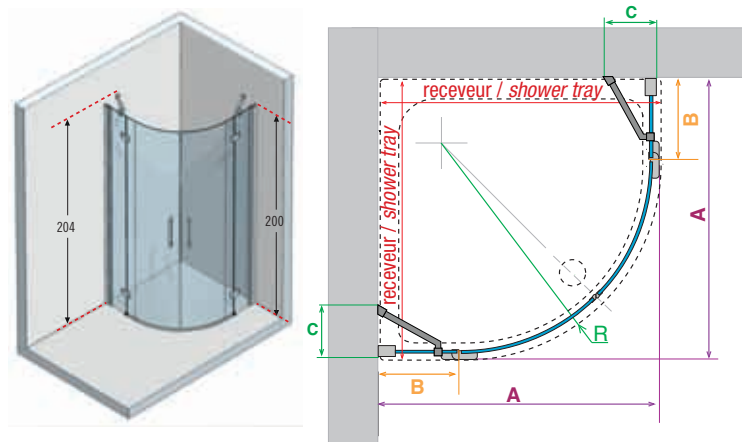

Code	Dimensions paroi de - a Measures shower trays from - to	A	B	C	R rayon radius
CORALR80	77,5 - 80	76,5-79	12-14,5	16	55
CORALR90	87,5 - 90	86,5-89	22-24,5	17	55
CORALR100	97,5 - 100	96,5-99	32-34,5	23	55

ref. **3** **Coral 2P** - Porte en niche 1 pivotant + 1 fixe
In line hinged door and panel for recess

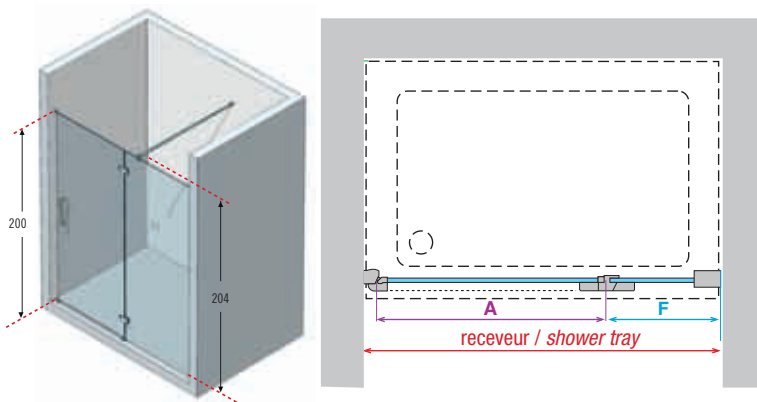

Code	Dimensions paroi de - a Measures shower trays from - to	A	F
SX CORAL2P120S-	117 - 119,5	62	52-54,5
DX CORAL2P120D-			
SX CORAL2P140S-	137 - 139,5	62	72-74,5
DX CORAL2P140D-			
SX CORAL2P160S-	157 - 159,5	72	82-84,5
DX CORAL2P160D-			
SX CORAL2P180S-	177 - 179,5	82	92-94,5
DX CORAL2P180D-			

ref. **5** **Coral 2A** - Porte à 4 panneaux en niche 2 pivotants + 2 fixes
Four section enclosure, two hinged + two fixed for recess

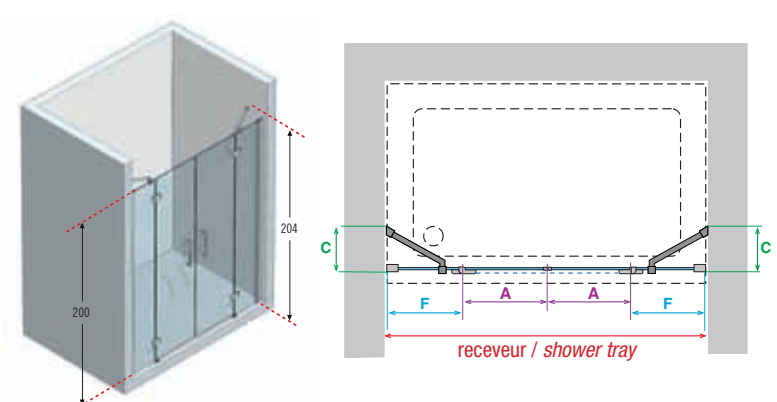

Code	Dimensions paroi de - a Measures shower trays from - to	A	F	C
CORAL2A120	115 - 120	35	22-24,5	17
CORAL2A140	135 - 140	35	32-34,5	23
CORAL2A150	145 - 150	40	32-34,5	23
CORAL2A160	155 - 160	45	32-34,5	23
CORAL2A170	165 - 170	40	42-44,5	27
CORAL2A180	175 - 180	45	42-44,5	27

CORAL